

# *A Practical Guide to 'Free Energy' Devices*

Part PatC2: Last updated: 22nd October 2005

Author: Patrick J. Kelly

Please note that this is a re-worded excerpt from this patent. A full copy can be downloaded free from the FreePatentsOnline.com web site.

**US Patent 1,997,497**

**9th April 1935**

**Inventor: Charles N. Pogue**

## **CARBURETTOR**

This invention relates to a device for obtaining an intimate contact between a liquid in a truly vaporous state and a gas, and particularly to such a device which may serve as a carburettor for internal combustion engines and is an improvement on the form of device shown in my Patent No. 1,938,497, granted on 5th December 1933.

In carburettors commonly used for supplying a combustible mixture of air and liquid fuel to internal combustion engines, a relatively large amount of the atomised liquid fuel is not vaporised and enters the engine cylinder more or less in the form of microscopic droplets. When such a charge is ignited in the engine cylinder, only that portion of the liquid fuel which has been converted into the vaporous, and consequently molecular state, combines with the air to give an explosive mixture. The remaining portion of the liquid fuel which is drawn into the engine cylinders remains in the form of small droplets and does not explode imparting power to the engine, but instead burns with a flame and raises the engine temperature above that at which the engine operates most efficiently, i.e. from 160<sup>0</sup> to 180<sup>0</sup> F.

In my earlier patent, there is shown and described a form of carburettor in which the liquid fuel is substantially completely vaporised prior to its introduction into the engine cylinders, and in which, means are provided for maintaining a reverse supply of "dry" vapour available for introduction into the engine cylinder. Such a carburettor has been found superior to the standard type of carburettor referred to above, and to give a better engine performance with far less consumption of fuel.

It is an object of the present invention to provide a carburettor in which the liquid fuel is broken up and prepared in advance of and independent of the suction of the engine and in which a reserve supply of dry vapour will be maintained under pressure, ready for introduction into the engine cylinder at all times. It is also an object of the invention to provide a carburettor in which the dry vapour is heated to a sufficient extent prior to being mixed with the main supply of air which carries it into the engine cylinder, to cause it to expand so that it will be relatively lighter and will become more intimately mixed with the air, prior to explosion in the engine cylinders.

I have found that when the reserve supply of dry vapour is heated and expanded prior to being mixed with the air, a greater proportion of the potential energy of the fuel is obtained and the mixture of air and fuel vapour will explode in the engine cylinders without any apparent burning of the fuel which would result in unduly raising the operating temperature of the engine.

More particularly, the present invention comprises a carburettor in which liquid fuel vapour is passed from a main vaporising chamber under at least a slight pressure, into and through a heated chamber where it is caused to expand and in which droplets of liquid fuel are either vaporised or separated from the vapour, so that the fuel finally introduced into the engine cylinders is in the true vapour phase. The chamber in which the liquid fuel vapour is heated and caused to expand, is preferably comprised of a series of passages through which the vapour and exhaust gases from the engine pass in tortuous paths in such a manner that the exhaust gasses are brought into heat interchange relation with the vapour and give up a part of their heat to the vapour, thus causing heating and expansion of the vapour.

The invention will be further described in connection with the accompanying drawings, but this further disclosure and description is to be taken merely as an exemplification of the invention and the invention is not limited to the embodiment so described.

## **DESCRIPTION OF THE DRAWINGS**

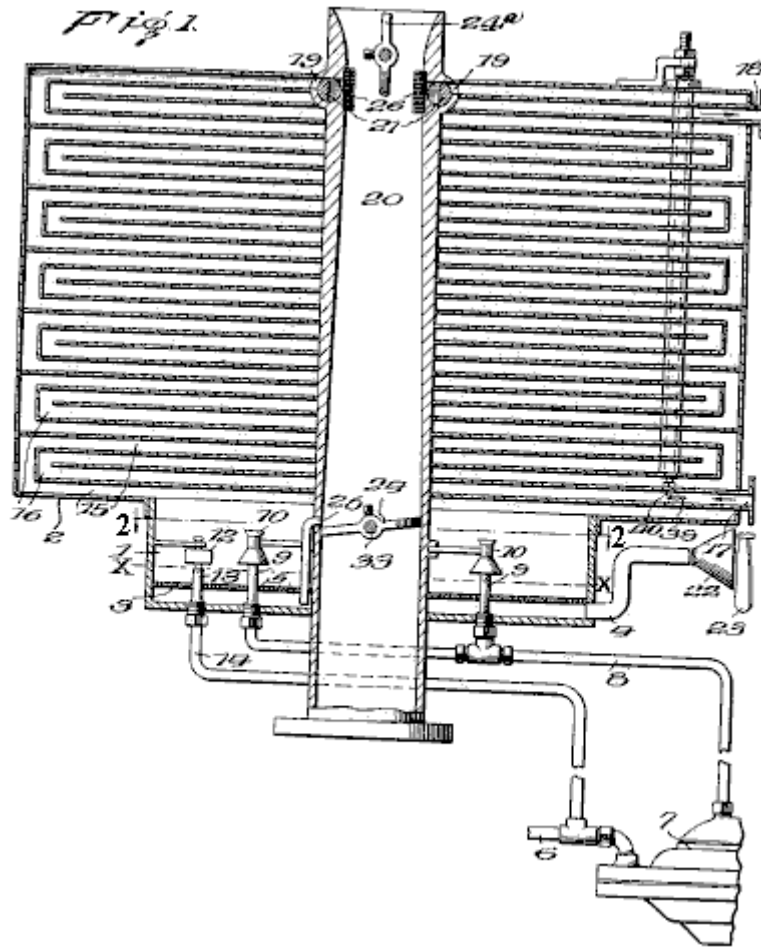

Fig.1 is a vertical cross-sectional view through a carburettor embodying my invention.

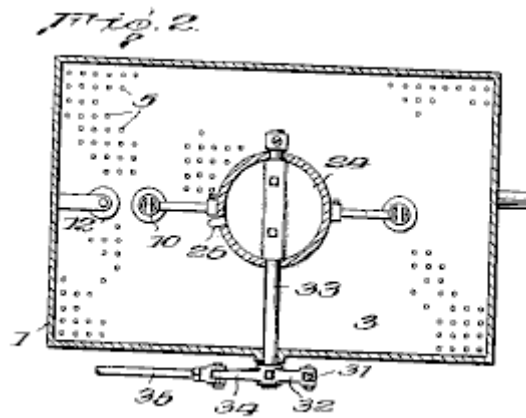

Fig.2 is a horizontal sectional view through the main vaporising or atomising chamber, taken on line 2--2 of Fig.1

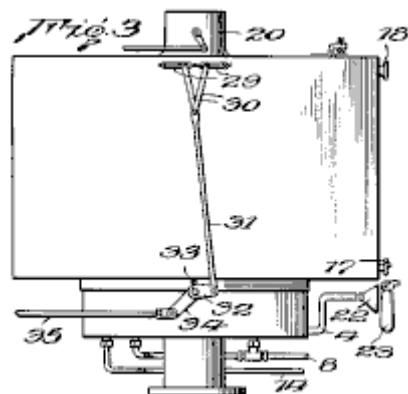
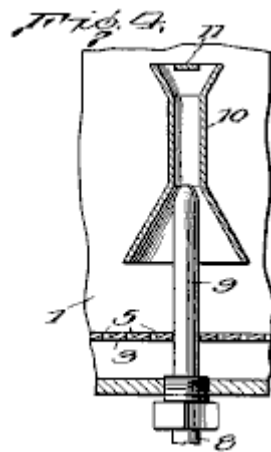
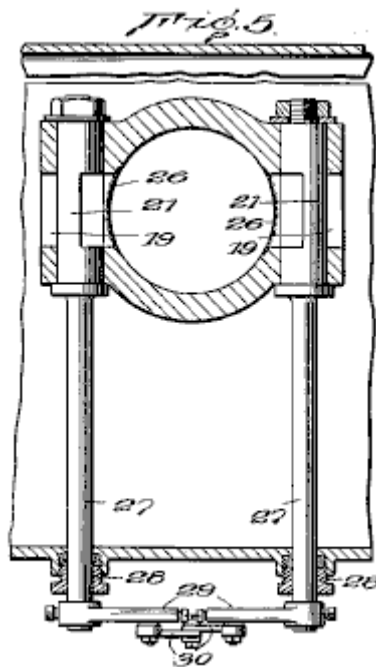

Fig.3 is a side elevation of the carburettor.



**Fig.4** is a detail sectional view of one of the atomising nozzles and its associated parts



**Fig.5** is a detail cross-sectional view showing the means for controlling the passage of gasses from the vapour expanding chamber into the intake manifold of the engine.

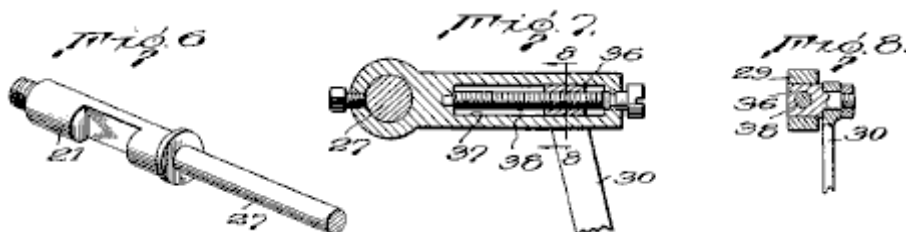

**Fig.6** is a perspective view of one of the valves shown in Fig.5

**Fig.7** is a cross-sectional view showing means for adjusting the valves shown in Fig.5

**Fig.8** is a cross-sectional view on line 8--8 of Fig.7

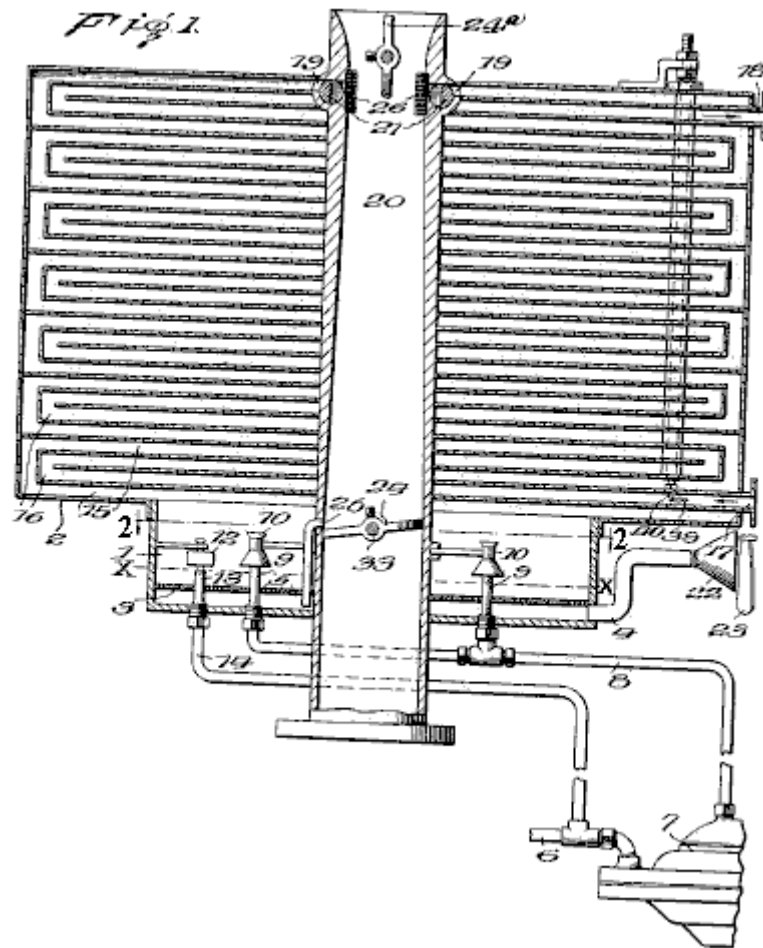

Referring now to the drawings, the numeral 1 indicates a main vaporising and atomising chamber for the liquid fuel located at the bottom of, and communicating with, a vapour heating and expanding chamber 2.

The vaporising chamber is provided with a perforated false bottom 3 and is normally filled with liquid fuel to the level x. Air enters the space below the false bottom 3 via conduit 4 and passes upwards through perforations 5 in the false bottom and then bubbles up through the liquid fuel, vaporising a portion of it.

To maintain the fuel level x in chamber 1, liquid fuel passes from the usual fuel tank (not shown) through pipe 8 into and through a pair of nozzles 9 which have their outlets located in chamber 1, just above the level of the liquid fuel in it. The pump 7 may be of any approved form but is preferably of the diaphragm type, as such fuel pumps are now standard equipment on most cars.

The nozzles 9 are externally threaded at their lower ends to facilitate their assembly in chamber 1 and to permit them to be removed readily, should cleaning be necessary.

The upper ends of nozzles 9 are surrounded by venturi tubes 10, having a baffle 11, located at their upper ends opposite the outlets of the nozzles. The liquid fuel being forced from the ends of nozzles 9 into the restricted portions of the Venturi tubes, causes a rapid circulation of the air and vapour in the chamber through the tubes 10 and brings the air and vapour into intimate contact with the liquid fuel, with the result that a portion of the liquid fuel is vaporised. The part of the liquid fuel which is not vaporised, strikes the baffles 11 and is further broken up and deflected downwards into the upward-flowing current of air and vapour.

Pump 7 is regulated to supply a greater amount of liquid fuel to the nozzles 9 than will be vaporised. The excess drops into chamber 1 and causes the liquid to be maintained at the indicated level. When the liquid fuel rises above that level, a float valve 12 is lifted, allowing the excess fuel to flow out through overflow pipe 13 into pipe 14 which leads back to pipe 6 on the intake side of pump 7. Such an arrangement allows a large amount of liquid fuel to be circulated by pump 7 without more fuel being withdrawn from the fuel tank than is actually vaporised and consumed in the engine. As the float valve 12 will set upon the end of the outlet pipe 13 as soon as the liquid level drops below the indicated level, there is no danger of vapour passing into pipe 14 and from there into pump 7 and interfere with its normal operation.

The upper end of the vaporising and atomising chamber **1** is open and vapour formed by air bubbling through the liquid fuel in the bottom of the chamber and that formed as the result of atomisation at nozzles **9**, pass into the heating and expanding chamber **2**. As is clearly shown in **Fig.1**, chamber **2** comprises a series of tortuous passages **15** and **16** leading from the bottom to the top. The fuel vapour passes through passages **15** and the exhaust gasses of the engine pass through passages **16**, a suitable entrance **17** and exit **18** being provided for that purpose.

The vapour passing upwards in a zigzag path through passages **15**, will be brought into heat interchange relation with the hot walls of the passages **16** traversed by the hot exhaust gasses. The total length of the passages **15** and **16** is such that a relatively large reserve supply of the liquid fuel is always maintained in chamber **2**, and by maintaining the vapour in heat interchange relation with the hot exhaust gasses for a substantial period, the vapour will absorb sufficient heat to cause it to expand, with the result that when it is withdrawn from the top of chamber **2**, it will be in the true vapour phase, and due to expansion, relatively light.

Any minute droplets of liquid fuel entrained by the vapour in chamber **1** will precipitate out in the lower passages **15** and flow back into chamber **1**, or else be vaporised by the heat absorbed from the exhaust gasses during its passage through chamber **2**.

The upper end of vapour passage **15** communicates with openings **19** adjacent to the upper end of a down-draft air tube **20** leading to the intake manifold of the engine. Valves **21** are interposed in openings **19**, so that the passage of the vapour through them into the air tube may be controlled. Valves **21** are preferably of the rotary plug type and are controlled as described below.

Suitable means are provided for causing the vapour to be maintained in chamber **2**, under a pressure greater than atmospheric, so that when the valves **21** are opened, the vapour will be forced into air tube **20** independent of the engine suction. Such means may comprise an air pump (not shown) for forcing air through pipe **4** into chamber **1** beneath the false bottom **3**, but I prefer merely to provide pipe **4** with a funnel-shaped inlet end **22** and placement just behind the usual engine fan **23**. This causes air to pass through pipe **4** with sufficient force to maintain the desired pressure in chamber **2**, and the air being drawn through the radiator by the fan will be preheated prior to its introduction into chamber **1** and hence will vaporise greater amounts of the liquid fuel. If desired, pipe **4** may be surrounded by an electric or other heater, or exhaust gasses from the engine may be passed around it to further preheat the air passing through it prior to its introduction into the liquid fuel in the bottom of chamber **1**.

Air tube **20** is provided with a butterfly throttle valve **24** and a choke valve **24a**, as is customary with carburettors used for internal combustion engines. The upper end of air tube **20** extends above chamber **2** a distance sufficient to receive an air filter and/or silencer, if desired.

A low-speed or idling jet **25** has its upper end communicating with the passage through air tube **20** adjacent to the throttling valve **24** and its lower end extending into the liquid fuel in the bottom of chamber **1**, for supplying fuel to the engine when the valves are in a position such as to close the passages **19**. However, the passage through idling jet **25** is so small that under normal operations, the suction on it is not sufficient to lift fuel from the bottom of chamber **1**.

To prevent the engine from backfiring into vapour chamber **2**, the ends of the passages **19** are covered with a fine mesh screen **26** which, operating on the principle of the miner's lamp, will prevent the vapour in chamber **2** from exploding in case of a backfire, but which will not interfere substantially with the passage of the vapour from chamber **2** into air tube **20** when valves **21** are open. Air tube **20** is preferably in the form of a venturi with the greatest restriction being at that point where the openings **19** are located, so that when valves **21** are opened, there will be a pulling force on the vapour caused by the increased velocity of the air at the restricted portion of air tube **20** opposite the openings **19**, as well as an expelling force on them due to the pressure in chamber **2**.

As shown in **Fig.3**, the operating mechanism of valves **21** is connected to the operating mechanism for throttle valve **24**, so that they are opened and closed simultaneously with the opening and closing of the throttle valve, ensuring that the amount of vapour supplied to the engine will, at all times, be in proportion to the demands placed upon the engine. To that end, each valve **21** has an extension, or operating stem **27**, protruding through one of the side walls of the vapour-heating and expanding chamber **2**. Packing glands **28** of ordinary construction, surround stems **27** where they pass through the chamber wall, to prevent leakage of vapour at those points.

Operating arms **29** are rigidly secured to the outer ends of stems **27** and extend towards each other. The arms are pivotally and adjustably connected to a pair of links **30** which, at their lower ends are pivotally connected to an operating link **31**, which in turn, is pivotally connected to arm **32** which is rigidly secured on an outer extension **33** of the stem of the throttle valve **24**. Extension **33** also has rigidly connected to it, arm **34** to which is connected operating link **35** leading from the means for accelerating the engine.

The means for adjusting the connection from the upper ends of links **30** to valve stems **27** of valves **21**, so that the amount of vapour delivered from chamber 2 may be regulated to cause the most efficient operation of the particular engine to which the carburettor is attached, comprises angular slides **36**, to which the upper ends of links **30** are fastened, and which cannot rotate but can slide in guideways **37** located in arms **29**. Slides **36** have threaded holes through which screws **38** pass. Screws **38** are rotatably mounted in arms **29**, but are held against longitudinal movement so that when they are rotated, slides **36** will be caused to move along the guideways **37** and change the relative position of links **30** to the valve stems **27**, so that a greater or less movement, and consequently, a greater or less opening of the ports **19** will take place when throttle valve **24** is operated.

For safety, and for most efficient operation of the engine, the vapour in chamber **2** should not be heated or expanded beyond a predetermined amount, and in order to control the extent to which the vapour is heated, and consequently, the extent to which it expands, a valve **39** is located in the exhaust passage **16** adjacent to inlet **17**. Valve **39** is preferably thermostatically controlled, as for example, by an expanding rod thermostat **40**, which extends through chamber **2**. However, any other means may be provided for reducing the amount of hot exhaust gasses entering passage **16** when the temperature of the vapour in the chamber reaches or exceeds the optimum.

The carburettor has been described in detail in connection with a down-draft type of carburettor, but it is to be understood that its usefulness is not to be restricted to that particular type of carburettor, and that the manner in which the mixture of air and vapour is introduced into the engine cylinders is immaterial as far as the advantages of the carburettor are concerned.

The term "dry vapour" is used to define the physical condition of the liquid fuel vapour after removal of liquid droplets or the mist which is frequently entrained in what is ordinarily termed a vapour.

From the foregoing description it will be seen that the present invention provides a carburettor in which the breaking up of the liquid fuel for subsequent use is independent of the suction created by the engine, and that after the liquid fuel is broken up, it is maintained under pressure in a heated space for a length of time sufficient to permit all entrained liquid particles to be separated or vaporised and to permit the dry vapour to expand prior to its introduction into and admixture with the main volume of air passing into the engine cylinders.

[www.free-energy-info.com](http://www.free-energy-info.com)  
[engpjk@yahoo.co.uk](mailto:engpjk@yahoo.co.uk)